

< 电路图 >

## 电路图





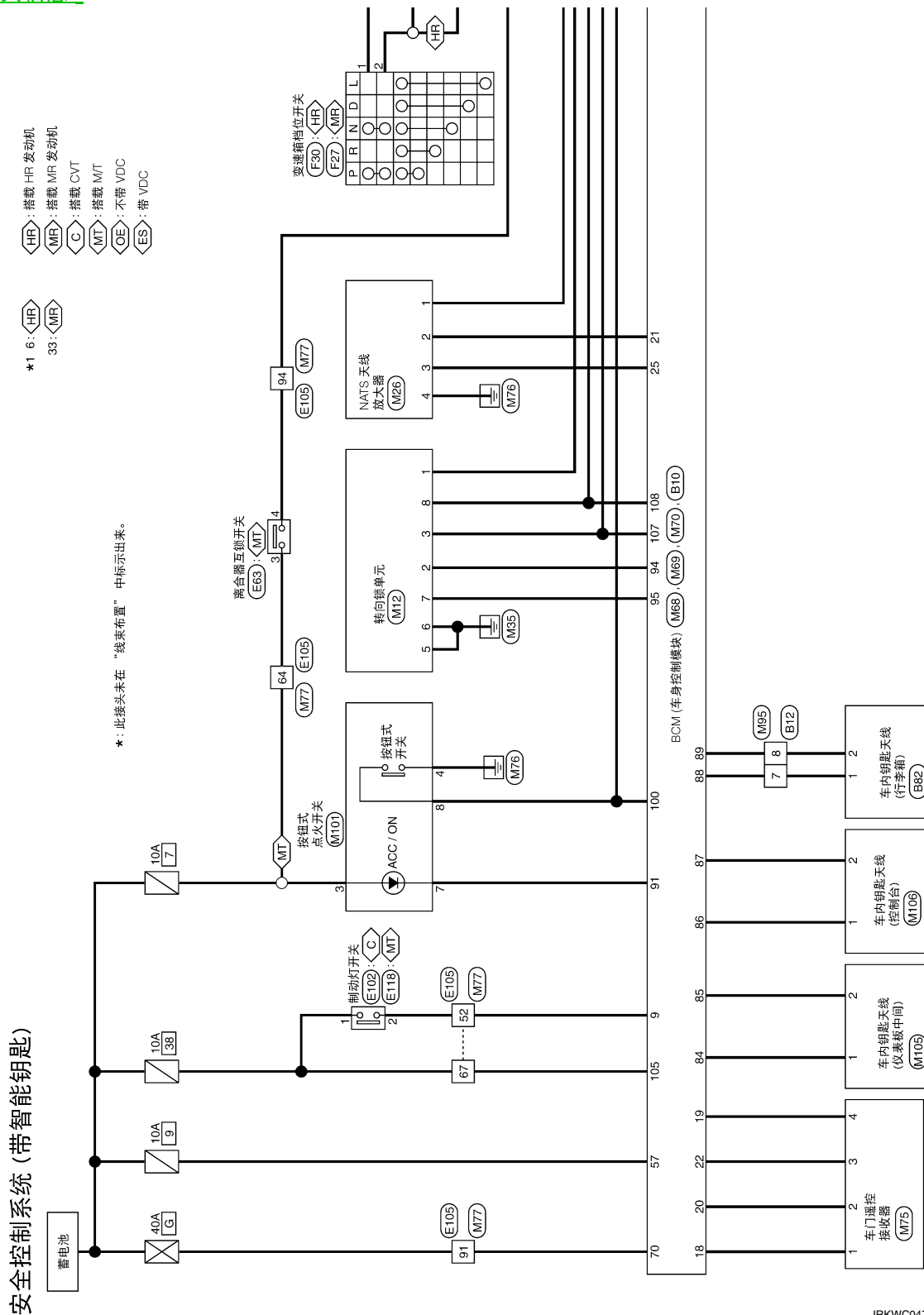

### 安全控制系统

#### 电路图

INFOID:000000007263867

有关接头端子布置、线束布置和在  (选装缩写标记; 如果在电路图中没有描述) 里面的字母, 请参见 [GL 12. "接头信息"](#)。



-  : 搭载 HR 发动机
-  : 搭载 MR 发动机
-  : 搭载 CVT
-  : 搭载 M/T
-  : 不带 VDC
-  : 带 VDC

\* 1 6:    
33: 

\*: 此接头未在“线束布置”中标示出来。



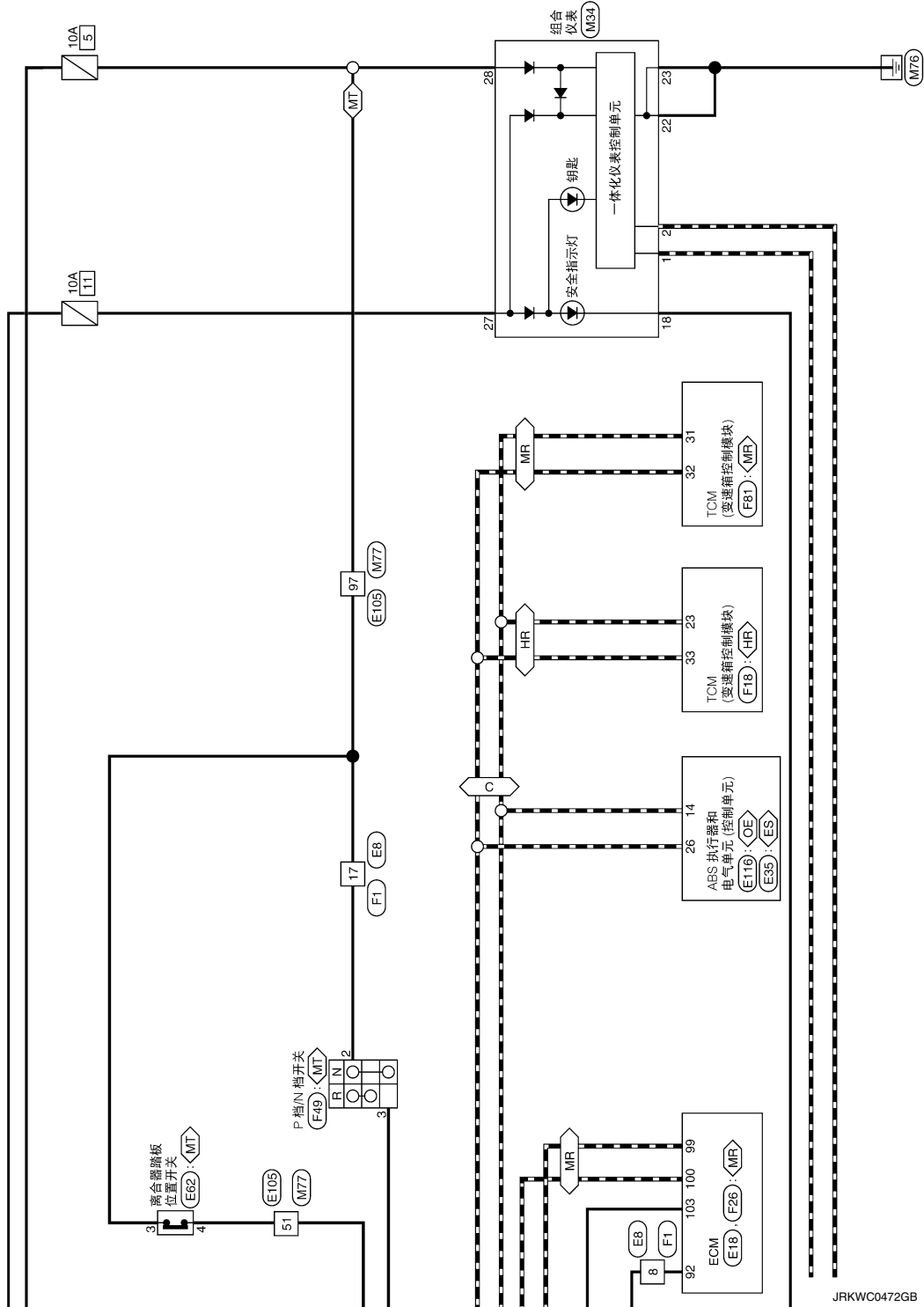

JRKWC0472GB